

DESIGNED
SWITCHES

Lithoss

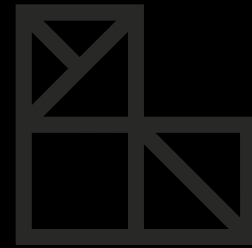

Void Round

01 Stainless Steel

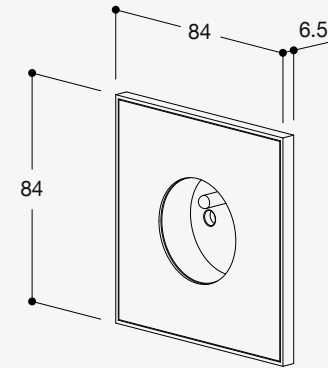

Socket Type	Color	Ref.
EU	White	Z
	Black	Y
FR/BE	White	X
	Black	W

Sockets included.

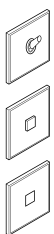

Combine

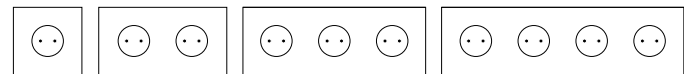

Ever thought about combining? Void works great with Cockpit, Select and Squares. For combinations and personalisation on demand, check page 221.

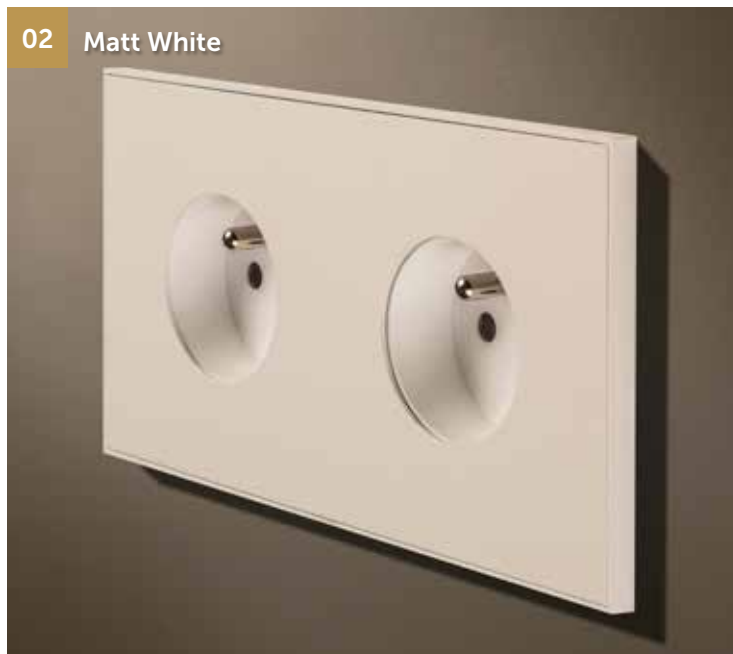

— Dimensions & wall boxes: see technical guide on page 199-201.

02 Matt White

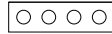

Socket Type				
EU	White	Vo0Z02	Vo0Z0Z02	Vo0Z0Z0Z02
	Black	Vo0Y02	Vo0Y0Y02	Vo0Y0Y0Y02
FR/BE	White	Vo0X02	Vo0X0X02	Vo0X0X0X02
	Black	Vo0W02	Vo0W0W02	Vo0W0W0W02



Void Round

13 Textured White

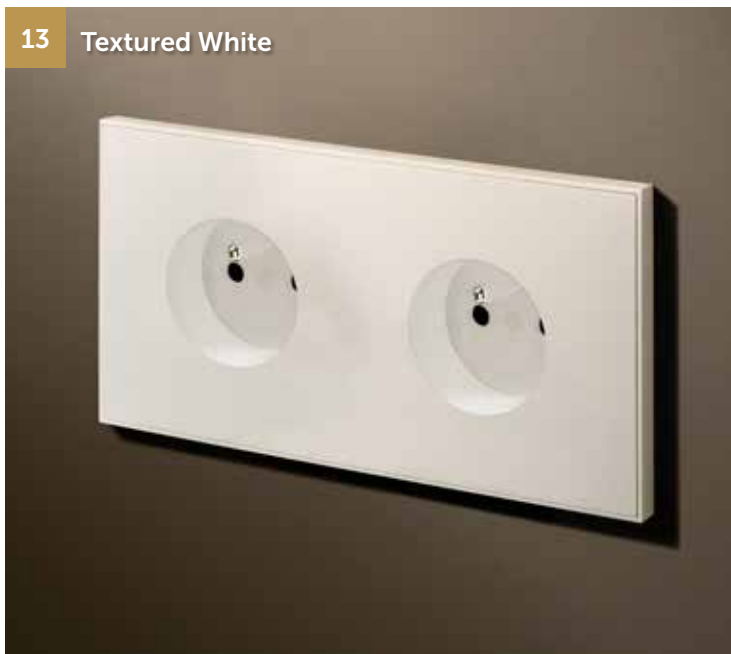

Socket Type					
EU	White	Vo0Z13	Vo0Z0Z13	Vo0Z0Z0Z13	Vo0Z0Z0Z0Z13
	Black	Vo0Y13	Vo0Y0Y13	Vo0Y0Y0Y13	Vo0Y0Y0Y0Y13
FR/BE	White	Vo0X13	Vo0X0X13	Vo0X0X0X13	Vo0X0X0X0X13
	Black	Vo0W13	Vo0W0W13	Vo0W0W0W13	Vo0W0W0W0W13





18 Matt Black RAL9011

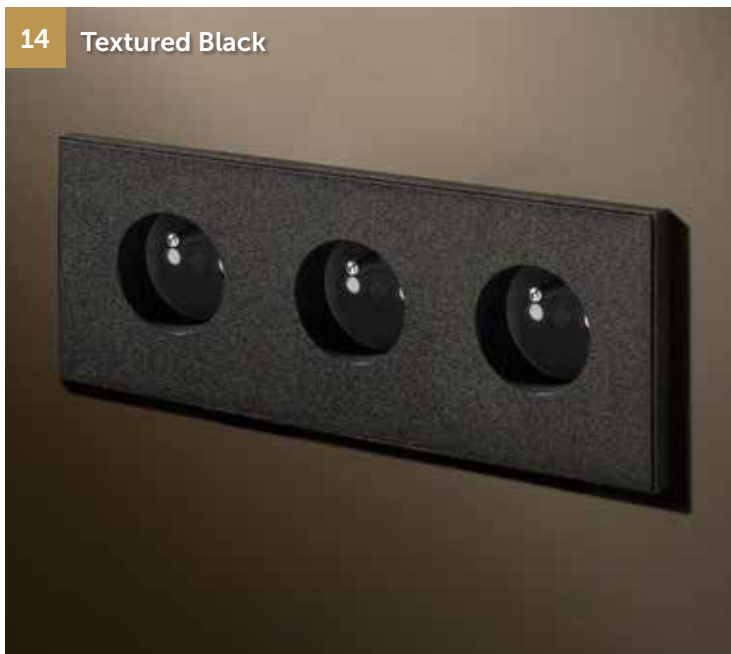

Socket Type					
EU	White	Vo0Z18	Vo0Z0Z18	Vo0Z0Z0Z18	Vo0Z0Z0Z0Z18
	Black	Vo0Y18	Vo0Y0Y18	Vo0Y0Y0Y18	Vo0Y0Y0Y0Y18
FR/BE	White	Vo0X18	Vo0X0X18	Vo0X0X0X18	Vo0X0X0X0X18
	Black	Vo0W18	Vo0W0W18	Vo0W0W0W18	Vo0W0W0W0W18

14 Textured Black



Socket Type				
EU	White	Vo0Z14	Vo0Z0Z14	Vo0Z0Z0Z14
	Black	Vo0Y14	Vo0Y0Y14	Vo0Y0Y0Y14
FR/BE	White	Vo0X14	Vo0X0X14	Vo0X0X0X14
	Black	Vo0W14	Vo0W0W14	Vo0W0W0W14

03 Gunpowder Black (Fusain)



Socket Type				
EU	White	Vo0Z03	Vo0Z0Z03	Vo0Z0Z0Z03
	Black	Vo0Y03	Vo0Y0Y03	Vo0Y0Y0Y03
FR/BE	White	Vo0X03	Vo0X0X03	Vo0X0X0X03
	Black	Vo0W03	Vo0W0W03	Vo0W0W0W03



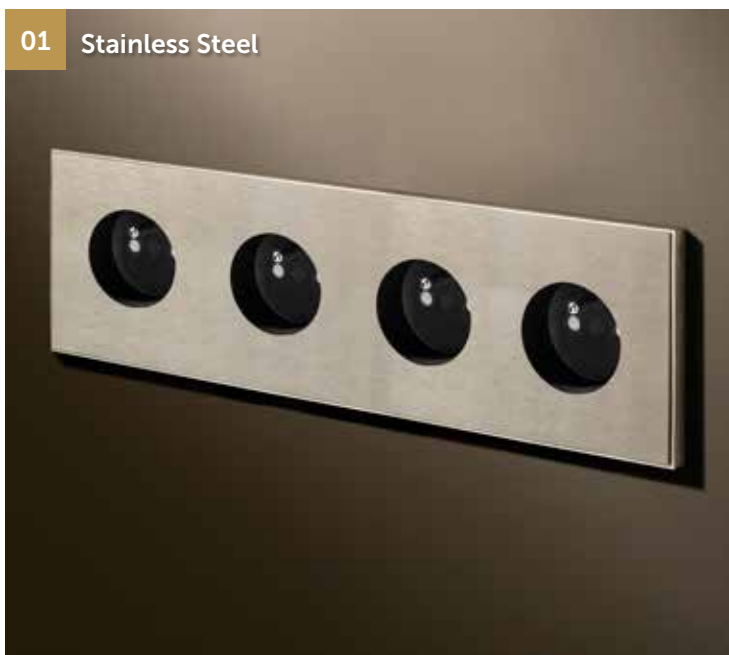

Void Round

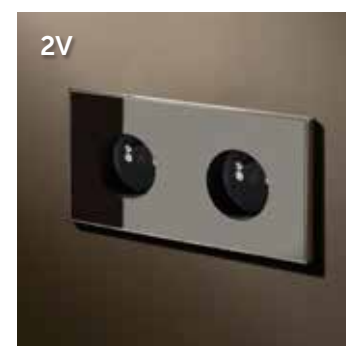

Socket Type				
EU	White	Vo0Z01	Vo0Z0Z01	Vo0Z0Z0Z01
	Black	Vo0Y01	Vo0Y0Y01	Vo0Y0Y0Y01
FR/BE	White	Vo0X01	Vo0X0X01	Vo0X0X0X01
	Black	Vo0W01	Vo0W0W01	Vo0W0W0W01

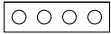

Socket Type				
EU	White	Vo0Z08	Vo0Z0Z08	Vo0Z0Z0Z08
	Black	Vo0Y08	Vo0Y0Y08	Vo0Y0Y0Y08
FR/BE	White	Vo0X08	Vo0X0X08	Vo0X0X0X08
	Black	Vo0W08	Vo0W0W08	Vo0W0W0W08

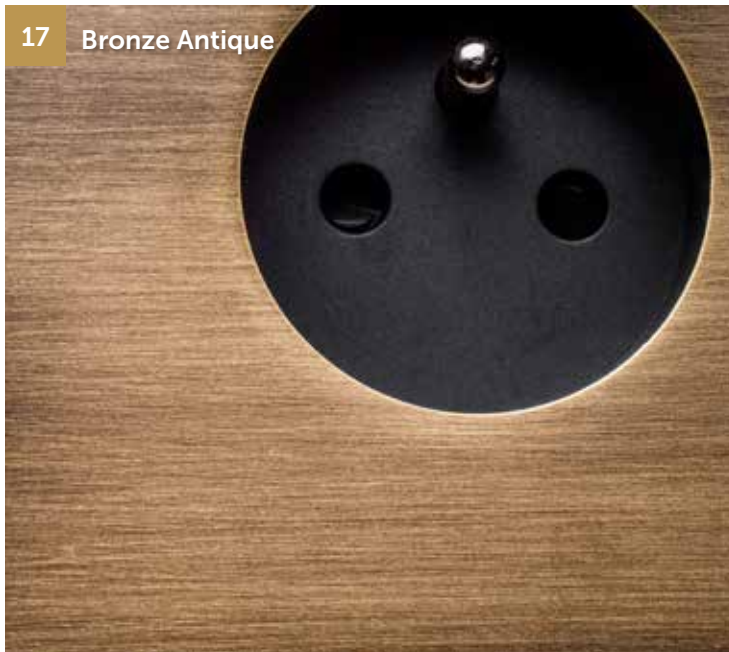

Socket Type				
EU	White	Vo0Z17	Vo0Z0Z17	Vo0Z0Z0Z17
	Black	Vo0Y17	Vo0Y0Y17	Vo0Y0Y0Y17
FR/BE	White	Vo0X17	Vo0X0X17	Vo0X0X0X17
	Black	Vo0W17	Vo0W0W17	Vo0W0W0W17

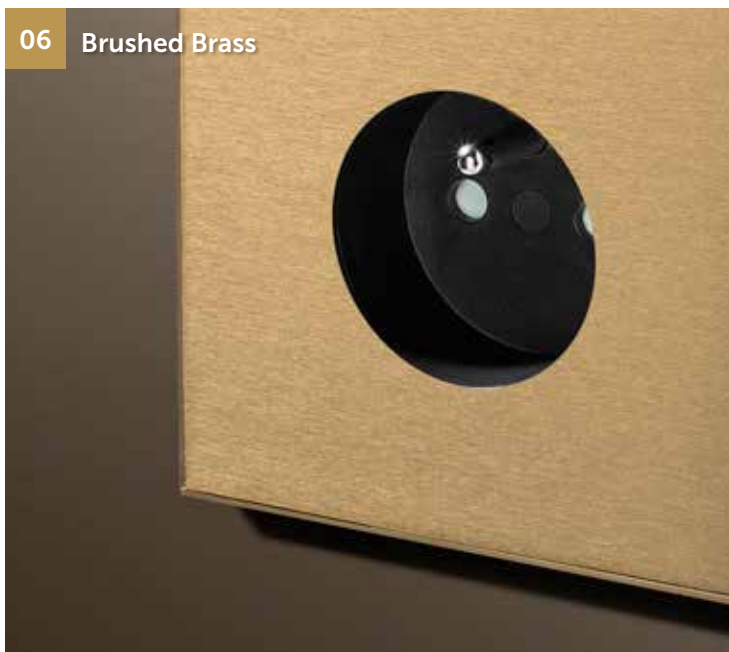

Socket Type				
EU	White	Vo0Z06	Vo0Z0Z06	Vo0Z0Z0Z06
	Black	Vo0Y06	Vo0Y0Y06	Vo0Y0Y0Y06
FR/BE	White	Vo0X06	Vo0X0X06	Vo0X0X0X06
	Black	Vo0W06	Vo0W0W06	Vo0W0W0W06



Void Round



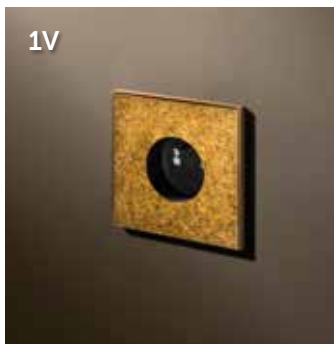
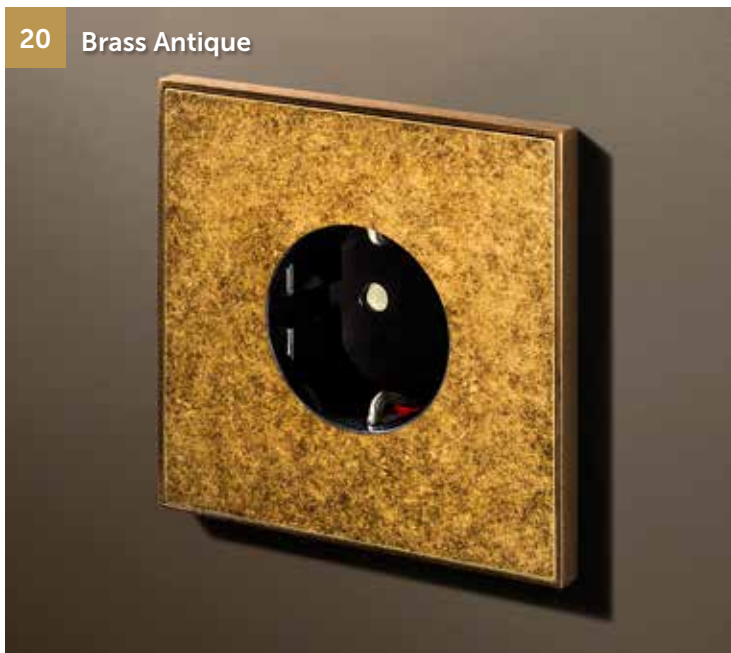

20 Brass Antique



Socket Type				
EU	White	Vo0Z20	Vo0Z0Z20	Vo0Z0Z0Z20
	Black	Vo0Y20	Vo0Y0Y20	Vo0Y0Y0Y20
FR/BE	White	Vo0X20	Vo0X0X20	Vo0X0X0X20
	Black	Vo0W20	Vo0W0W20	Vo0W0W0W20

19 Tin Antique



Socket Type				
EU	White	Vo0Z19	Vo0Z0Z19	Vo0Z0Z0Z19
	Black	Vo0Y19	Vo0Y0Y19	Vo0Y0Y0Y19
FR/BE	White	Vo0X19	Vo0X0X19	Vo0X0X0X19
	Black	Vo0W19	Vo0W0W19	Vo0W0W0W19

29 Copper

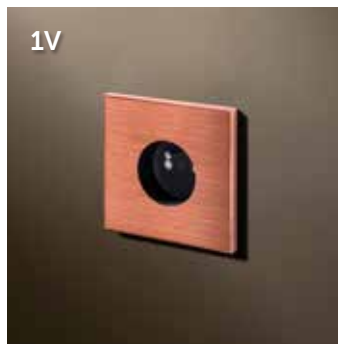

Socket Type				
EU	White	Vo0Z29	Vo0Z0Z29	Vo0Z0Z0Z29
	Black	Vo0Y29	Vo0Y0Y29	Vo0Y0Y0Y29
FR/BE	White	Vo0X29	Vo0X0X29	Vo0X0X0X29
	Black	Vo0W29	Vo0W0W29	Vo0W0W0W29

09 Nickel

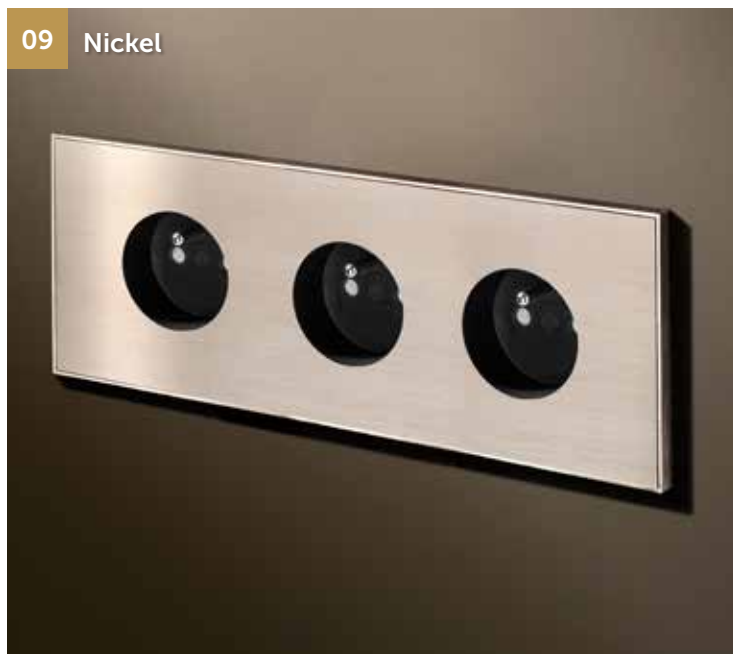

Socket Type				
EU	White	Vo0Z09	Vo0Z0Z09	Vo0Z0Z0Z09
	Black	Vo0Y09	Vo0Y0Y09	Vo0Y0Y0Y09
FR/BE	White	Vo0X09	Vo0X0X09	Vo0X0X0X09
	Black	Vo0W09	Vo0W0W09	Vo0W0W0W09

