

DESIGNED
SWITCHES

Lithoss

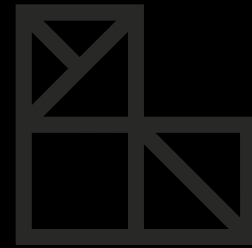

Luminaires

Microscoop

29 Copper

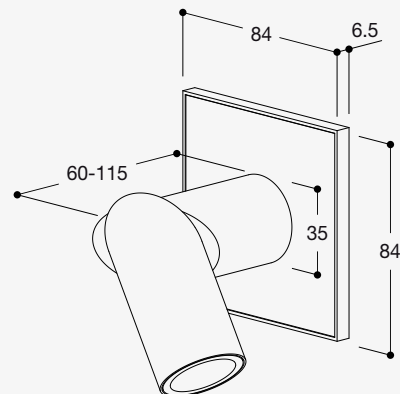

Available in

⊙ 24V / 250V	⚡ 2 Way (250V - 10A)
⊙ 24V + feedback led white	⊙ Push Button (250V - 10A)
⊙ 24V + feedback led amber	⚡ 2 Way + Neon (250V - 10A)
Ⓚ KNX sensor	⊙ Push Button + Neon (250V - 10A)

Lamp specifications: 4W led / 2700K / 400 lumen

13 Textured White



1T

01 Stainless Steel

















1T

Type	Ref.
24V / 250V	Ni310M13
24V + led white	Ni710M13
24V + led amber	Ni810M13
KNX (led & temp sensor)	NiK10M13

Type	Ref.
24V / 250V	Ni310M01
24V + led white	Ni710M01
24V + led amber	Ni810M01
KNX (led & temp sensor)	NiK10M01



	Technology	Ref.
 Solo		Lu0Mxx
 1T	⊙ 24V-250V push button	Ni310Mxx
	⊙ 24V + led white	Ni710Mxx
	⊙ 24V + led amber	Ni810Mxx
	 KNX (led & temp sensor)	NiK10Mxx
 2T left	⊙ 24V-250V push button	Ni320Mxx
	⊙ 24V + led white	Ni720Mxx
	⊙ 24V + led amber	Ni820Mxx
	 KNX (led & temp sensor)	NiK20Mxx
 2T right	⊙ 24V-250V push button	Ni0M32xx
	⊙ 24V + led white	Ni0M72xx
	⊙ 24V + led amber	Ni0M82xx
	 KNX (led & temp sensor)	Ni0MK2xx

	Technology	Ref.
 4T	⊙ 24V-250V push button	Ni340Mxx
	⊙ 24V + led white	Ni740Mxx
	⊙ 24V + led amber	Ni840Mxx
	 KNX (led & temp sensor)	NiK40Mxx
 1C	 250V 2-way	Co110Mxx
	 250V 2-way + neon	Co410Mxx
 2C	 250V 2-way	Co120Mxx
	 250V 2-way + neon	Co420Mxx

xx Add the color code at the end for any color you desire.

— Available in Stainless Steel [01], Textured White [13], Textured Black [14], Copper [29] & Copper + Textured Black [34].